

E045

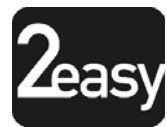
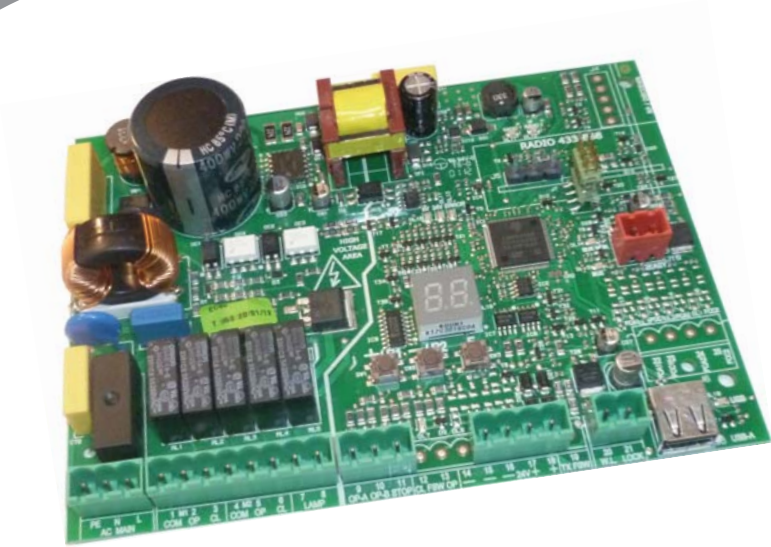

FAAC

CE DECLARATION OF CONFORMITY**Manufacturer:** FAAC S.p.A.**Address:** Via Calari, 10 - 40069 Zola Predosa BOLOGNA - ITALY**Declares that:** E045 remote Programmer

conforms to the essential safety requirements of the following EEC directives

2006/95/EC Low Voltage Directive

2004/108/EC Electromagnetic Compatibility Directive

Additional note:

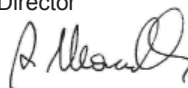
this product underwent tests in a typical uniform configuration
(all products manufactured by FAAC S.p.A.).Bologna, january the 1st 2012The Managing Director
A. Marcellan

WARNINGS FOR THE INSTALLER

GENERAL SAFETY OBLIGATIONS

1. **ATTENTION!** To ensure the safety of people, it is important that you read all the following instructions. Incorrect installation or incorrect use of the product could cause serious harm to people.
2. Carefully read the instructions before beginning to install the product.
3. Do not leave packing materials (plastic, polystyrene, etc.) within reach of children as such materials are potential sources of danger.
4. Store the instructions for future reference.
5. This product was designed and built strictly for the use indicated in this documentation. Any other use, not expressly indicated here, could compromise the good condition/operation of the product and/or be a source of danger.
6. FAAC S.p.A. declines all liability caused by improper use or use other than that for which the automated system was intended.
7. Do not install the equipment in an explosive atmosphere: the presence of inflammable gas or fumes is a serious danger to safety.
8. FAAC S.p.A. is not responsible for failure to observe Good Technique in the construction of the closing elements to be motorised, or for any deformation that may occur during use.
9. The installation must conform to Standards EN 12453 and EN 12445. For non-EU countries, to obtain an adequate level of safety, the Standards mentioned above must be observed, in addition to national legal regulations.
10. Before attempting any job on the system, cut out electrical power and disconnect the batteries if present.
11. The mains power supply of the automated system must be fitted with an all-pole switch with contact opening distance of 3mm or greater. Use of a 6A thermal breaker with all-pole circuit break is recommended.
12. Make sure that a differential switch with threshold of 0.03 A is fitted upstream of the system.
13. Make sure that the earthing system is perfectly constructed, and connect metal parts of the means of the closure to it.
14. The automated systems that feature a built-in anti-crushing safety device in any case require a functional check in accordance with the provisions of the Standards indicated at point 9.
15. The safety devices (EN 12978 standard) protect any danger areas against mechanical movement Risks, such as crushing, dragging, shearing, lifting.
16. Use of at least one indicator-light (e.g.: flashing lamp) is recommended for every system, as well as a warning sign adequately secured.
17. FAAC S.p.A. declines all liability as concerns safety and efficient operation of the automated system, if system components not produced by FAAC S.p.A. are used.
18. For maintenance, strictly use original parts by FAAC S.p.A.
19. Do not in any way modify the components of the automated system.
20. The installer shall provide the User with all information concerning manual operation of the system in case of an emergency.
21. Do not allow children or adults to stay near the product while it is operating.
22. Keep radio controls or other pulse generators away from children, to prevent the automated system from being activated involuntarily.
23. Transit is allowed only when the automation is fully open.
24. The User must not attempt any kind of repair or direct action whatever and contact qualified personnel only.
25. Anything not expressly specified in these instructions is not permitted.

MEANING OF THE SYMBOLS USED



Important for the safety of persons and for the good condition of the automated system.



Notes on the characteristics and operation of the product.

INDEX

CE DECLARATION OF CONFORMITY	2
WARNINGS FOR THE INSTALLER	3
1. TECHNICAL SPECIFICATIONS	5
2. PREPARING FOR INSTALLATION	6
3. BOARD LAYOUT	6
4. ELECTRICAL CONNECTIONS	8
4.1 J1 - PRIMARY MAINS POWER SUPPLY	8
4.2 J2 - MOTORS AND FLASHING LAMP	8
4.3 J3 - COMMAND AND SAFETY DEVICES INPUTS	9
4.4 J9 - ACCESSORIES POWER SUPPLY	10
4.5 J11 - INDICATOR LIGHT/ELECTRIC LOCK OUTPUTS	10
4.6 J10 - BUS-2EASY ACCESSORIES	11
BUS-2EASY photocells	11
Address assignment of BUS-2EASY photocells	12
Connection of BUS-2EASY photocells	12
BUS-2EASY encoder	13
Connection - Address assignment of BUS-2EASY Encoder	13
4.7 J5 - XF MODULE RAPID CONNECTOR	14
5. PROGRAMMING	15
5.1 BASIC PROGRAMMING FUNCTIONS	16
5.2 ADVANCED PROGRAMMING FUNCTIONS	21
5.3 BUS-2EASY DEVICE INSTALLATION	24
5.3.1 BUS-2EASY DEVICE ENTRY	24
Checking the securing devices entered on the board	25
5.4 TIME LEARNING - SETUP	26
5.5 TESTING THE AUTOMATED SYSTEM	27
6. MEMORISING THE RADIO CODE	28
6.1 MEMORISING THE SLH/SLH LR RADIO CONTROLS	28
6.2 MEMORISING LC/RC RADIO CONTROLS (ONLY 433 MHZ)	29
6.2.1 REMOTE MEMORISATION OF LC/RC RADIO CONTROLS	30
6.3 MEMORISING DS RADIO CONTROLS	30
6.4 DELETING THE RADIO CONTROLS	31
7. START-UP	32
7.1 CHECKING THE LEDs	32
8. SIGNALLING ERRORS AND ALARMS	33
8.1 ERRORS	33
8.2 ALARMS	34
9. TROUBLESHOOTING	34
10. MANAGING THE CONFIGURATION FILE – J8 USB	35
11. FUNCTION LOGICS	38

CONTROL BOARD E045

We thank you for having chosen one of our products. **FAAC** is certain that from it you will obtain all the performance you require. All our products are the result of years of experience in the field of automated systems.

1. TECHNICAL SPECIFICATIONS

PURPOSE: this control board has been designed and built to control swing-leaf gates for vehicle and pedestrian access control.

During programming you can choose between different **function logics**.

2 programming levels are available from the board (BASIC and ADVANCED), using buttons and LCD display.

Tab. Technical specifications

Mains power supply	With power supply switching 230 V~ ± 15% ; 50/60Hz	
Power absorbed from mains	Stand By = 4W ; MAX about 800 W	
MAX load for motors	800 W	
Accessories power supply	24 V $\overline{=}$	
MAX. accessories current	+24V MAX 500 mA	BUS-2EASY MAX 500 mA
	LOCK (FAAC) 12 V~ / 24 V $\overline{=}$	
Operating ambient temperature	from -20°C to +55°C	
Power supply safety fuses	F1 = 2,5 A	
Work time	Self-learned through SETUP - (Max 4 min and 10 sec)	
Pause time	Programmable (from 0 to 9 min and 50 sec)	
Motor power	Programmable on 50 levels	
Connector inputs	XF433/868 Module, USB	
Terminal board inputs	Mains power supply, BUS-2EASY, OPEN-A, OPEN-B, STOP	
Terminal board outputs	Flashing lamp, Motors, Electric lock (LOCK), OUT1, Accessories power supply	

2. PREPARING FOR INSTALLATION

⚠ For safety reasons, it is important for people to carefully follow all the warnings and instructions contained in this manual. Incorrect installation or incorrect use of the product can cause serious harm to people. Before proceeding with product installation, carefully read the entire manual. Keep these instructions for further reference.

⚠ Always cut off the electrical power before carrying out any work on the control unit (connections, maintenance).

Always separate the power cables from the control and safety cables (button, receiver, BUS-2EASY encoder, photocells, etc.). Avoid any electrical disturbance using separate sheathing or a shielded cable (with shield connected to the earth).

- Ensure that upstream of the system there is a suitable magnetothermic differential switch with omnipolar cut-off, as provided for in current safety regulations.
- Check for the presence of an adequate earthing system.

3. BOARD LAYOUT

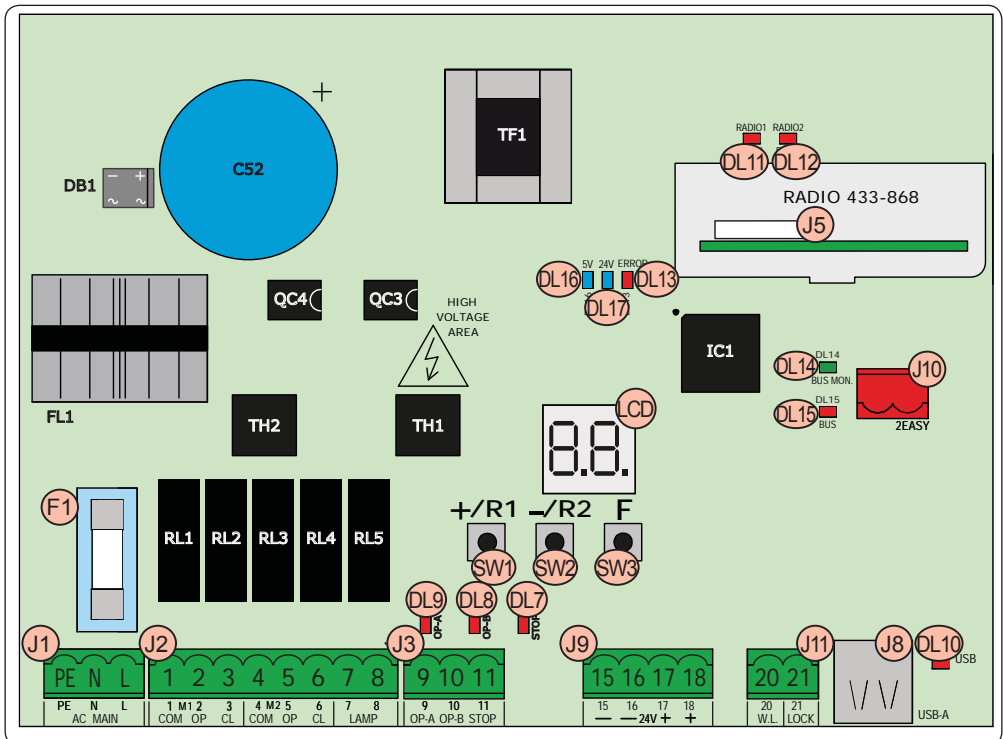

LCD	Signalling/Programming display
SW1	“+R1” Programming button
SW2	“-R2” Programming button
SW3	“F” Programming button
DL7	“STOP” Input status control LED
DL8	“OP-B” Input status control LED
DL9	“OP-A” Input status control LED
DL10	“USB” Signalling LED
DL11	“RADIO1-XF” Signalling LED (OMNIDEC)
DL12	“RADIO2-XF” Signalling LED (OMNIDEC)
DL13	“ERROR” Error/alarm signalling LED
DL14	“BUS MON”BUS-2EASY diagnostic signalling LED
DL15	Device signalling LED to BUS-2EASY ACTIVE
DL16	Microprocessor power presence LED
DL17	+24V Accessories power supply presence LED
J1	230 V~ ± 15% Power supply connector
J2	Motors and flashing lamp power supply connector
J3	Input connector
J5	XF433/XF868 (OMNIDEC) receiver module connector
	Channel 1 - OPEN A (Total Opening)
	Channel 2 - OPEN B (Partial Opening)
J8	HOST USB-A for Mass Memories connector
J9	+24V Accessories power supply connector
J10	BUS-2EASY Device connector
J11	Indicator Light/ Electric Lock output connector
F1	Motor and power supply safety fuse

4. ELECTRICAL CONNECTIONS

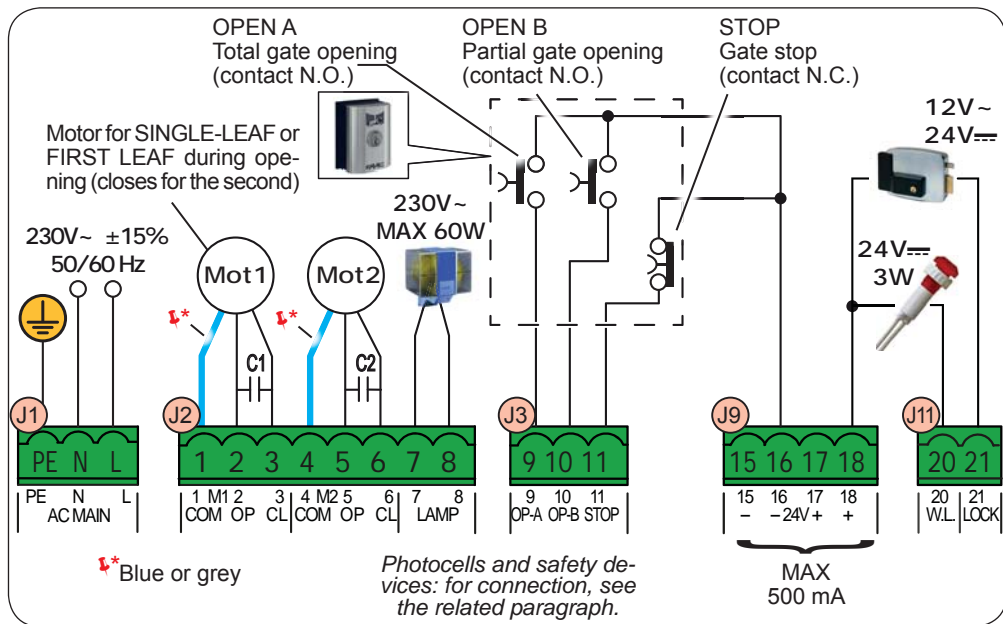

4.1 J1 - PRIMARY MAINS POWER SUPPLY

PE	Earthing Connection
N	Power Supply Connection 230 V ~ ± 15% Neutral
L	Power Supply Connection 230 V ~ ± 15% Line

⚠ For correct operation, you must connect the switching power supply to the system's earthing conductor. Ensure that upstream a suitable differential magnetothermic switch has been installed.

4.2 J2 - MOTORS AND FLASHING LAMP

1	M1 - COM	Common contact motor 1
2	M1 - OP	OP phase motor 1
3	M1 - CL	CL phase motor 1
4	M2 - COM	Common contact motor 2
5	M2 - OP	OP phase motor 2
6	M2 - CL	CL phase motor 2
7	LAMP	Flashing lamp connection (MAX 60 W)
8		

☞ M1 = first leaf when opening or single leaf
M2 = second leaf when opening - **CAN-NOT** be used for single leaf

☞ To verify correct wiring and direction of motor rotation, (see 6.4 TIME LEARNING - SETUP)

4.3 J3 - COMMAND AND SAFETY DEVICES INPUTS

9	OP-A	OPEN A contact - N.O. TOTAL opening	Connect a button or other pulse generator which, by closing a contact, commands TOTAL opening of both leaves.
10	OP-B	OPEN B contact - N.O. PARTIAL opening	<p>Connect a button or other pulse generator which, by closing a contact, commands the PARTIAL opening.</p> <p> on 2-motor systems = 100% of leaf 1 opening; on 1-motor systems = 50% of leaf 1 opening.</p> <p>When a logic requiring a CLOSE (b, c) input is selected, the, OPEN B input automatically becomes CLOSE - N.O. (leaves closing command).</p>
<p><i>To install more than one OPEN A or OPEN B pulse generator, connect the N.O. contacts in parallel (see related Fig.)</i></p>			
11	STOP	STOP contact - N.C.	Connect a button or other pulse generator which, by opening a contact, stops movement of the automated system .
<p><i>To install more than one STOP device, connect the N.C. contacts in series (see related Fig.). If stop devices are NOT connected, jumper terminals STOP and GND.</i></p>			

Fig. e.g.: Connecting 2 N.O. contacts in parallel.

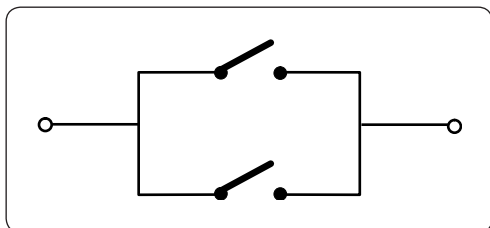
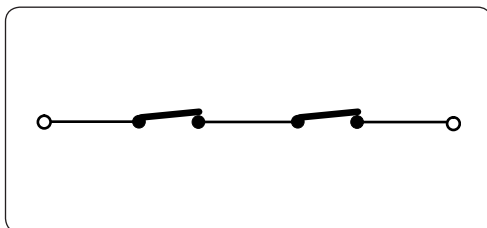

Fig. e.g.: Connecting 2 N.C. contacts in series.



4.4 J9 - ACCESSORIES POWER SUPPLY

15	-	GND Accessories power supply negative
16		
17	+	+24 Accessories power supply positive (MAX. load = 500mA)
18		

4.5 J11 - INDICATOR LIGHT/ELECTRIC LOCK OUTPUTS

20	W.L.	Indicator Light Output 24 V \Rightarrow - MAX Load 100mA	
21	LOCK	Electric lock (12 V \sim or 24 V \Rightarrow) operated 2 sec before opening of leaf 1	<p>When BUS-2EASY encoder is disabled, the electric lock is operated before each opening (in whatever position the leaf is in).</p> <p>When BUS-2EASY encoder is enabled, the electric lock is operated before opening, only if the leaf is closed position.</p>

4.6 J10 - BUS-2EASY ACCESSORIES

This board features a **BUS-2EASY** circuit for facilitating connection to the safety devices of a high number of auxiliary BUS-2EASY (MAX 16 pairs of photocells), encoder and control devices.

 **If no BUS-2EASY accessories are used, leave the BUS-2EASY connector free.**

BUS-2EASY photocells

Before connecting the photocells, arrange them for the duly address assignment, depending on their position and operation mode:

Photocells during closing: trip only during the closing of the automated system - suitable for protecting the closing area from risk of impact.

Photocells during opening: trip only during the opening of the automated system - suitable for protecting the opening area from risk of impact.

Photocells during opening/closing: trip during both the opening and closing - suitable for protecting the entire movement area from risk of impact.

Pulse generators: used as pulse generators for opening the automated system.

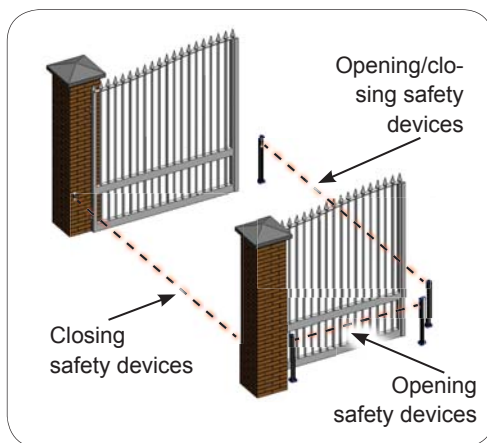

 **Should use of traditional photocells be required, you must use a BUS Interface Module to be connected to the BUS-2EASY J10 terminal.**

For further information, refer to the BUS Interface Module instructions.

Address assignment of BUS-2EASY photocells

To assign the address to each pair of photocells, you must set the Dip-Switches (**DS1**) located on the transmitter and corresponding receiver.

 **The transmitter and receiver of a pair of photocells must have the same DIP-SWITCH setting.**

Two or more pairs of photocells must not have the same DIP-SWITCH setting.

Dip1	Dip2	Dip3	Dip4	TYPE OF PHOTOCELLS
OFF	OFF	OFF	OFF	OPENING (max 6 pairs)
OFF	OFF	OFF	ON	
OFF	OFF	ON	OFF	
OFF	OFF	ON	ON	
OFF	ON	ON	OFF	
OFF	ON	ON	ON	
ON	OFF	OFF	OFF	CLOSING (max 7 pairs)
ON	OFF	OFF	ON	
ON	OFF	ON	OFF	
ON	OFF	ON	ON	
ON	ON	OFF	OFF	
ON	ON	OFF	ON	
ON	ON	ON	OFF	OPENING and CLOSING (max 2 pairs)
OFF	ON	OFF	OFF	
OFF	ON	OFF	ON	
ON	ON	ON	ON	OPEN PULSE (1 pair)

Connection of BUS-2EASY photocells

For connecting you have to use two cables without polarity (see the specific device instructions).

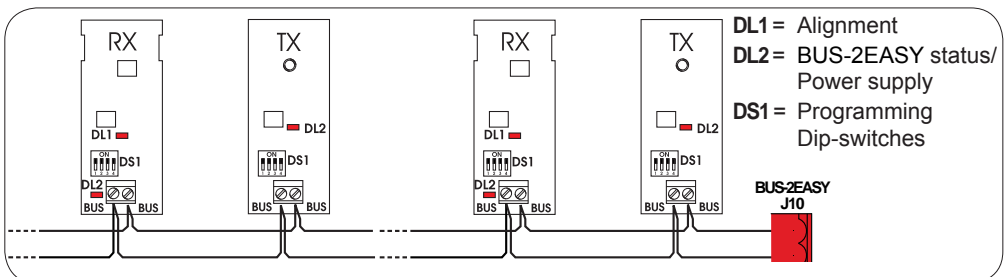

BUS-2EASY encoder connection is done using the bi-polar cables supplied with.

Connection - Address assignment of BUS-2EASY Encoder

⚠ *The polarity of the BUS-2EASY line connection determines the correspondence of the encoder to one leaf or the other.*

pay careful attention to the indications of the status LEDs located on the body of each encoder.

LEAF 1 opens first and closes last.

ENGLISH

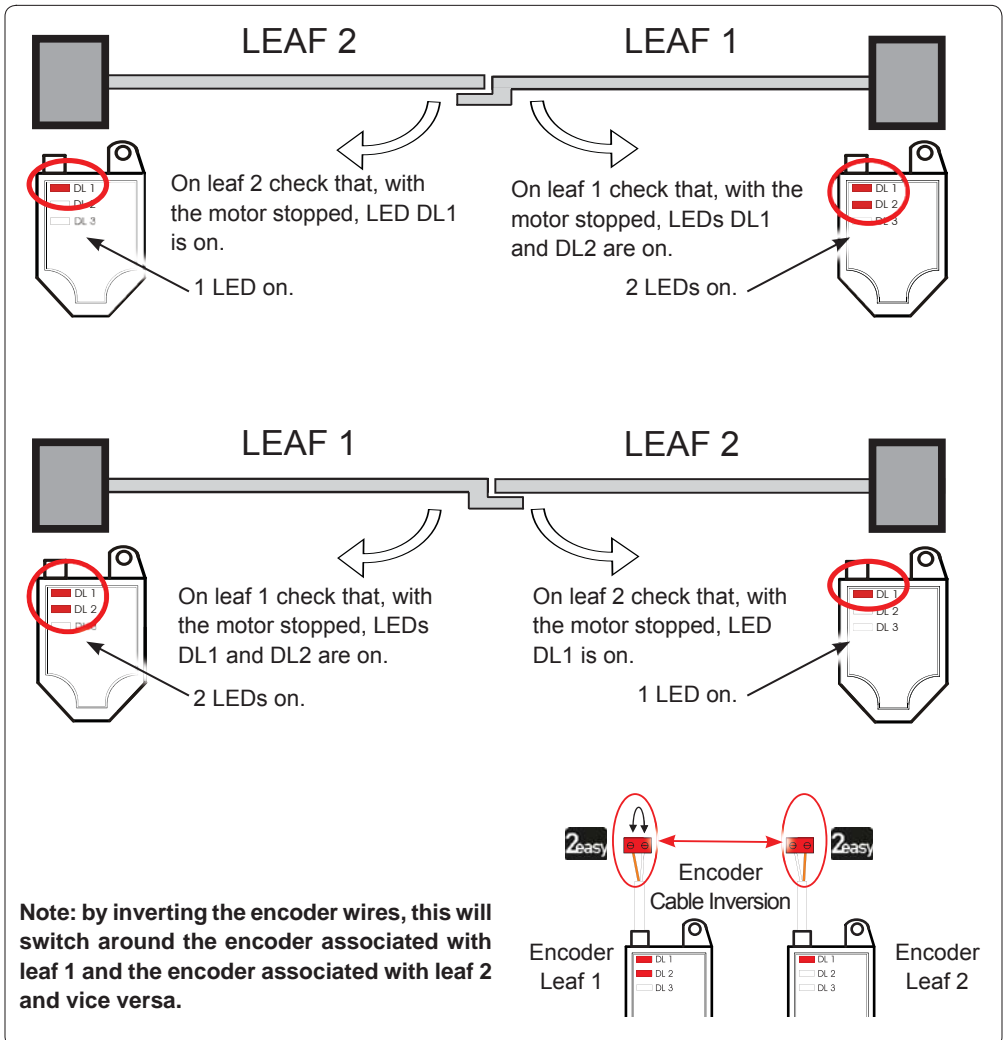

Tab. BUS-2EASY Encoder LEDs Status

LED	ON	FLASHING	OFF
DL1	Power present	Power present	Power absent
	Communication present	Communication absent	Communication absent
<i>DL1 must always be on to confirm correct encoder/board connection.</i>			
DL2	Leaf 1	/	Leaf 2
	<i>DL2 indicates the leaf on which the encoder is installed; it must be on for leaf 1 and off for leaf 2.</i>		
DL3	Stationary leaf	Leaf in motion	Stationary leaf
	<i>DL3 indicates pulse reading during leaf movement using steady flashing. In stationary status of the leaf, the DL3 can be either on or off.</i>		

 **In case of incorrect connection (DL2 on or off for both of the encoders), during the BUS-2EASY accessories learning procedure, the DL1 leds of both encoders are FLASHING.**

4.7 J5 - XF MODULE RAPID CONNECTOR

Plug-in rapid connector dedicated to OMNIDEC 2-channel decoding module.



ALWAYS cut off power to the board BEFORE inserting/removing the module.

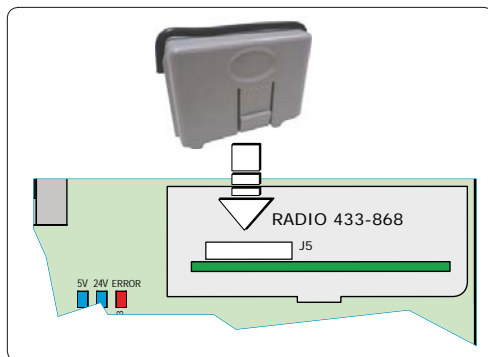

5. PROGRAMMING

Programming is divided in two levels:

- **BASIC programming**
- **ADVANCED programming**

The programming phases are (see **Tab.**):

1. to access PROGRAMMING (**1A** or **1B**);
2. to show the set values and modify them, if you want. *Changing the values is effective immediately, while the final memorisation must be carried out upon exiting programming (St).*
3. exit the programming by using **St** function. Select **y** to SAVE the configuration you just performed, otherwise select **no** to EXIT WITHOUT SAVING any changes.

You can **EXIT programming at anytime**:

- press and hold **F** and then also **-** to switch directly to **St**.

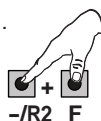

Tab. BASIC programming phases.

1	2	3
<p>PRESS AND HOLD F:</p> <p>THE FIRST FUNCTION APPEARS ¹</p>	<p>RELEASE F: THE FUNCTION VALUE IS DISPLAYED</p>	<p>USING + OR -, SCROLL THE AVAILABLE VALUES UNTIL THE DESIRED ONE</p> <p>+/R1 -/R2</p>
<p>PRESS F: TO MOVE TO THE NEXT FUNCTION ¹</p>	<p>FUNCTION St (LAST FUNCTION)</p> <p>SELECT y TO SAVE THE PROGRAMMING</p> <p>OTHERWISE SELECT no TO EXIT THE PROGRAMMING WITHOUT SAVING</p>	<p>PRESS THE BUTTON F TO CONFIRM; AT THE END THE DISPLAY RETURNS TO VISUALIZE THE AUTOMATED SYSTEM STATUS</p>

















Tab. ADVANCED programming phases





1	2	3
<p>PRESS AND HOLD F AND THEN ALSO +:</p> <p>THE FIRST FUNCTION APPEARS ¹</p> <p>+/R1 F</p>	<p>RELEASE THE BUTTONS: THE FUNCTION VALUE IS DISPLAYED</p> <p>+/R1 F</p>	<p>USING + OR -, SCROLL THE AVAILABLE VALUES UNTIL THE THE DESIRED ONE</p> <p>+/R1 -/R2</p>
<p>PRESS F: TO MOVE TO THE NEXT FUNCTION ¹</p>	<p>FUNCTION St (LAST FUNCTION)</p> <p>SELECT y TO SAVE THE PROGRAMMING</p> <p>OTHERWISE SELECT no TO EXIT THE PROGRAMMING WITHOUT SAVING</p>	<p>PRESS THE BUTTON F TO CONFIRM; AT THE END THE DISPLAY RETURNS TO VISUALIZE THE AUTOMATED SYSTEM STATUS</p>



¹ THE FUNCTION IS DISPLAYED UNTIL YOU HOLD

5.1 BASIC PROGRAMMING FUNCTIONS









































ENGLISH

Display	Basic Function	Default
	<p>DEFAULT:</p> <p> indicates that all the set values correspond to the default values.</p> <p> indicates that one or more set values are different from the default.</p> <p>Set  if you want to restore the default settings.</p>	
	<p>FUNCTION LOGICS:</p> <ul style="list-style-type: none">  Semi-automatic  Semi-automatic Step-by-Step  Automatic Step-by-Step Safety Devices  Automatic  Automatic Step-by-Step  Semi-automatic "b"  Dead-man <p> When a logic requiring a CLOSE () input is selected, the OPEN B inputs will automatically be changed to CLOSE. , if you choose a logic that does not require the use of CLOSE inputs, these inputs will change to OPEN B.</p> <p><i>For a description of how the logics operate, see the related paragraph.</i></p>	























Display	Basic Function	Default
	<p>PAUSE A and PAUSE B TIME (visualised only with Automatic logics)</p> <p>Is the pause time in a TOTAL opening and PARTIAL opening (it is enabled only if a logic with pause time has been selected).</p> <p>Adjustable from 00 to 59 sec, in 1-second steps.</p> <p>Next the value 59, the viewing changes to minutes and tenths of a second (separated by a decimal point) and time is adjusted in 10-second steps up to the maximum value of 9.5 minutes.</p> <p><i>e.g.: if the display shows 2.5, the time is 2 min and 50 sec.</i></p>	
	<p>NR. OF MOTORS:</p> <p>You can select the number of motors present in the system:</p> <p>1 = 1 motor 2 = 2 motors</p> <p> <i>If the SETUP is performed with only one motor, and later two motors are used, the board will signal error 14 - configuration error, which can be deleted by repeating the SETUP with two motors or by returning to one motor.</i></p> <p><i>If a SETUP is performed with two motors and later only one is used, the board will not signal an error. Only the motor connected to input M1 will move.</i></p>	

Display	Basic Function	Default
F1	<p>MOTOR 1 POWER:</p> <p>You can adjust the maximum power of motor 1, which is the same during both opening and closing.</p> <p>01 = minimum power 50 = maximum power</p> <p> If the power is modified, we recommend performing a new SETUP - see the related paragraph.</p> <p>If hydraulic motors are used, power must be programmed to maximum level (50).</p>	25
F2	<p>MOTOR 2 POWER (visualised only with the function $M_n = 2$):</p> <p>You can adjust the maximum power of motor 2, which is the same during both opening and closing.</p> <p>01 = minimum power 50 = maximum power</p> <p> If the power is modified, we recommend performing a new SETUP - see the related paragraph.</p> <p>If hydraulic motors are used, power must be programmed to maximum level (50).</p>	25
En	<p>ENCODER USE:</p> <p>You can enable/disable the use of encoders:</p> <p>y = encoders on both motors no = encoders disabled</p>	no
Cd	<p>DELAY FOR CLOSING LEAF (visualised only with the function $M_n = 2$):</p> <p>Is the delay time for starting leaf 1 closing with respect to leaf 2. Makes it possible to avoid overlapping of the two leaves.</p> <p>Adjustable from 00 to 59 sec, in 1- second steps.</p> <p>Next the value 59, the viewing changes to minutes and tenths of a second (separated by a decimal point) and time is adjusted in 10-second steps up to the maximum value of 1.3 minutes.</p> <p>e.g.: if the display shows 1.2, the time is 1 min and 20 sec</p>	05









































Display	Basic Function	Default
bu	BUS-2EASY DEVICES ENTRY: <i>See the related paragraph.</i>	no
m2	MOTOR 2 dead-man DRIVE mode (visualised only with the function $M_n = 2$) +/R1 <input type="checkbox"/> OPENS (visualising oP) until the button is held down -/R2 <input type="checkbox"/> CLOSES (visualising cL) until the button is held down	--
m1	MOTOR 1 dead-man DRIVE mode +/R1 <input type="checkbox"/> OPENS (visualising oP) until the button is held down -/R2 <input type="checkbox"/> CLOSES (visualising cL) until the button is held down	--
tl	WORK TIME LEARNING (SETUP): <i>See the related paragraph.</i>	--

Display	Basic Function	Default		
	<p>AUTOMATED SYSTEM STATUS:</p> <p>You can exit programming, choosing whether or not to save the configuration you just performed.</p> <ol style="list-style-type: none"> set the choice: <ul style="list-style-type: none">  to SAVE and EXIT the programming  to EXIT the programming WITHOUT SAVING press the button F to confirm; at the end the display returns to visualize the automated system status: <table border="0" style="width: 100%;"> <tr> <td style="width: 50%; vertical-align: top;"> <p> = CLOSED</p> <p> = OPEN</p> <p> = Stationary then "OPENS"</p> <p> = Stationary then "CLOSES"</p> <p> = In "PAUSE"</p> <p> = during Opening</p> <p> = during Closing</p> </td> <td style="width: 50%; vertical-align: top;"> <p> = FAIL SAFE in progress</p> <p> = checking BUS-2EASY devices in progress</p> <p> = Pre-flash then "OPENS"</p> <p> = Pre-flash then "CLOSES"</p> </td> </tr> </table> <p>⚠ WARNING <i>If power is lost to the board prior to confirmation (step 2.), all changes made will be lost.</i></p> <p> You can EXIT programming at any time: press and hold F and then also  to switch directly to .</p> <p> -/R2 F</p>	<p> = CLOSED</p> <p> = OPEN</p> <p> = Stationary then "OPENS"</p> <p> = Stationary then "CLOSES"</p> <p> = In "PAUSE"</p> <p> = during Opening</p> <p> = during Closing</p>	<p> = FAIL SAFE in progress</p> <p> = checking BUS-2EASY devices in progress</p> <p> = Pre-flash then "OPENS"</p> <p> = Pre-flash then "CLOSES"</p>	
<p> = CLOSED</p> <p> = OPEN</p> <p> = Stationary then "OPENS"</p> <p> = Stationary then "CLOSES"</p> <p> = In "PAUSE"</p> <p> = during Opening</p> <p> = during Closing</p>	<p> = FAIL SAFE in progress</p> <p> = checking BUS-2EASY devices in progress</p> <p> = Pre-flash then "OPENS"</p> <p> = Pre-flash then "CLOSES"</p>			

5.2 ADVANCED PROGRAMMING FUNCTIONS

Display	Advanced Function	Default
	<p>REVERSE STROKE IN OPENING and RAM STROKE IN CLOSING:</p> <p>You can enable/disable reverse stroke and ram stroke.</p> <p>The reverse stroke facilitates releasing the electric lock: when the automated system is closed, before to start opening, the motors give a short drive toward closing.</p> <p>The Ram Stroke facilitate the latching of the electric lock: activating the the motors at maximum power during the end of closing.</p> <p> = enabled (for 2 sec)  = disabled</p> <p> <i>In case of systems with an absolute encoder, to enable this function a setup must be performed using the automatic leaf stop on the mechanical contact point.</i></p>	
	<p>DELAY FOR OPENING LEAF (visualised only with the function $M_n = 2$):</p> <p>You can enable/disable the delay for starting leaf 2 opening with respect to leaf 1, in order to avoid overlapping of the two leaves.</p> <p> = enabled (for 2 sec)  = disabled</p>	
	<p>LEAF 1 DECELERATION:</p> <p>You can adjust the deceleration space as a percentage of the total travel of leaf 1.</p> <p>Adjustable from  to  %, in 1% steps.</p> <p> = no deceleration  = minimum deceleration space  = maximum deceleration space</p>	
	<p>LEAF 2 DECELERATION (visualised only with the function $M_n = 2$):</p> <p>You can adjust the deceleration space as a percentage of the total travel of leaf 2.</p> <p>Adjustable from  to  %, in 1% steps.</p> <p> = no deceleration  = minimum deceleration space  = maximum deceleration space</p>	

Display	Advanced Function	Default
PF	<p>PRE-FLASHING:</p> <p>You can enable/disable the pre-flashing. Pre-flashing duration = 3 sec.</p> <p>Y = enabled before each movement no = disabled</p>	no
EC	<p>ANTI-CRUSHING SENSITIVITY (visualised only with the function En = Y):</p> <p>Varying this function varies the amount of time after which, in case of obstacle, the board commands reversal of the leaves, or it will command a stop if the leaves are in the contact point search space (see the parameter r8). The fourth consecutive obstacle detected in the same direction and position will be defined as a contact point and the leaf will stop in that position.</p> <p>00 = minimum sensitivity (maximum time before reversal) 10 = maximum sensitivity (minimum time before reversal)</p>	05
r8	<p>CONTACT POINT SEARCH ANGLE (visualised only with the function En = Y):</p> <p>You can adjust the contact point search angle within which the board will stop movement without reversing, if it encounters an obstacle or the contact point.</p> <p>Adjustable in two modes:</p> <p>01 = Low contact point search space (about 1 degree) 02 = High contact point search space (about 4 degree)</p>	02
tA	<p>ADDITIONAL OPERATING TIME (displayed only if function En = no and functions Fc and FA = no or = 02):</p> <p>You can add a work time at the end of movement. Adjustable from 0 to 30 sec in 1 sec steps.</p> <p> This time is not considered when calculating the deceleration percentage.</p>	03

Display	Advanced Function	Default														
	<p>AUTOMATED SYSTEM STATUS:</p> <p>You can exit programming, choosing whether or not to save the configuration you just performed.</p> <ol style="list-style-type: none"> set the choice: <ul style="list-style-type: none">  to SAVE and EXIT the programming  to EXIT the programming WITHOUT SAVING press the button F to confirm; at the end the display returns to visualize the automated system status: <table border="0"> <tr> <td> = CLOSED</td> <td> = FAIL SAFE in progress</td> </tr> <tr> <td> = OPEN</td> <td> = checking BUS-2EASY devices in progress</td> </tr> <tr> <td> = Stationary then "OPENS"</td> <td> = Pre-flash then "OPENS"</td> </tr> <tr> <td> = Stationary then "CLOSES"</td> <td> = Pre-flash then "CLOSES"</td> </tr> <tr> <td> = In "PAUSE"</td> <td></td> </tr> <tr> <td> = Opening</td> <td></td> </tr> <tr> <td> = Closing</td> <td></td> </tr> </table> <p> WARNING <i>If power is lost to the board prior to confirmation (step 2.), all changes made will be lost.</i></p> <p> You can EXIT programming at any time: press and hold F and then also = to switch directly to .</p> <p> -/R2 F</p>	 = CLOSED	 = FAIL SAFE in progress	 = OPEN	 = checking BUS-2EASY devices in progress	 = Stationary then "OPENS"	 = Pre-flash then "OPENS"	 = Stationary then "CLOSES"	 = Pre-flash then "CLOSES"	 = In "PAUSE"		 = Opening		 = Closing		
 = CLOSED	 = FAIL SAFE in progress															
 = OPEN	 = checking BUS-2EASY devices in progress															
 = Stationary then "OPENS"	 = Pre-flash then "OPENS"															
 = Stationary then "CLOSES"	 = Pre-flash then "CLOSES"															
 = In "PAUSE"																
 = Opening																
 = Closing																

5.3 BUS-2EASY DEVICE INSTALLATION

You can add BUS-2EASY devices to the system at any time, proceeding as follows:

1. Cut off the electrical power to the board.
2. Install and set the BUS-2EASY accessories according to the instructions of the devices.
3. Connect the BUS-2EASY devices according to the instructions of Chapter **ELECTRICAL CONNECTIONS**.
4. Power up the board.
5. Complete the procedure for BUS-2EASY device entry.

5.3.1 BUS-2EASY DEVICE ENTRY

1. Access BASIC programming and scroll through the functions up until **b_u**. When **F** is released, the display will show the BUS-2EASY devices status (see the figure).
2. Perform the entry: simultaneously press and hold **+** and **-** for at least 5 sec (during this time, the display will blink).
3. **4** will appear as a confirmation of entry completion.
4. Release the **+** and **-** buttons. The status of the BUS-2EASY devices will be displayed.

 If no BUS device has ever been entered in the board, the display will read **no**.

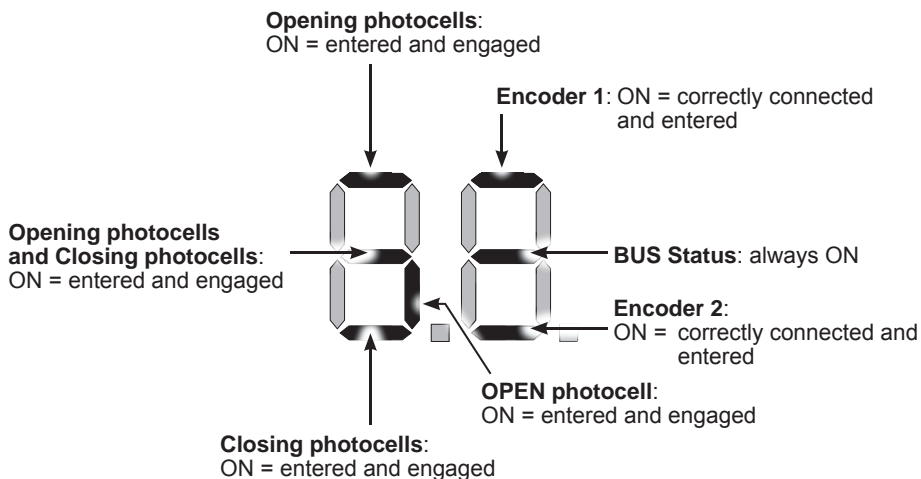
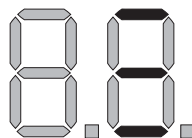

Fig. Visualising the BUS-2EASY status in the function **b_u**: each segment of the display shows one type of device.

Fig. examples of BUS-2EASY status visualization on display.

In STAND BY (gate closed and in stand-by) with BUS-2EASY **Encoder** on leaf 1 and leaf 2 and BUS-2EASY **Photocells** correctly connected and entered.



In case of BUS-2EASY **Encoder** on leaf1 and leaf 2 and BUS-2EASY **Photocells** correctly connected and entered and with closing photocells engaged:



Checking the securing devices entered on the board

To verify the types of BUS device recognised through the entry:

1. Press and hold the **+** button during stand-by visualisation; the segments corresponding to at least one entered device will go ON. E.g.:

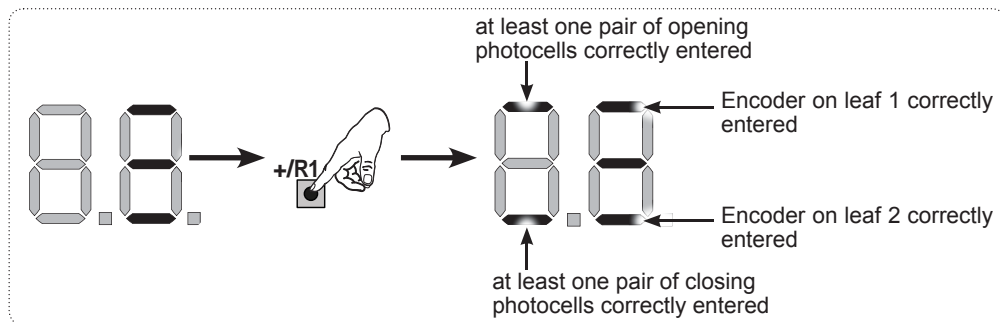

To check the condition of the BUS-2EASY connection, verify the LED on the board:

LED DL15 (Red)

ON	Safety device engaged or pulse generator active
OFF	NO safety device engaged neither pulse generator active

LED DL14 (Green)

ON steady	Normal activity (led ON even if there are no devices).
Slow blinking (blink every 2,5 sec)	BUS-2EASY line short-circuit.
Rapid blinking (blink every 0.5 sec)	Error in the BUS-2EASY connection. Repeat the device entry. If the error occurs again, check: - That there are no more than one device in the system with the same address. - Calling error (number > or < the connected BUS devices). - FAIL SAFE error on the BUS device.
OFF	Board in Sleep mode (if used).

5.4 TIME LEARNING - SETUP

When the board is powered, if a SETUP has never been performed, or if the board requests it, on the display **50** indicates that a SETUP must be performed.

 During SETUP, the connected BUS-2EASY accessories are always entered.

 The BUS-2EASY encoders are to be enabled before SETUP: set the parameter $E_n = 4$ (see BASIC Programming)

For SETUP, proceed as follows:

 **During SETUP all safety devices are disabled! Therefore, carry out the operation avoiding any transit in the leaf movement area.**

 If a system without an encoder is installed, mechanical stops will be required for the leaves.

1. Enter BASIC programming and go to the parameter E_L , when F is released **--** will appear.

2. Ensure that the gate leaves are closed. Otherwise, proceed as follows:

- Press and hold -/R2 to close leaf 2
- Press and hold +/R1 to close leaf 1

 Should pressing +/R1 and/or -/R2 command opening of the corresponding leaf, cut off power and, on terminal board J2, invert the phase cables of the corresponding motor (terminals 2-3 for leaf 1 motor and terminals 5-6 for leaf 2 motor).

3. With the gate leaves closed, launch SETUP by pressing and holding **+** and **-** until **51** begins to flash on the display (about 3 sec).

4. Release **+** e **-**. Leaf 1 begins its opening movement.

Operation WITHOUT Encoder

Stop movement by sending an OPEN A pulse as soon as leaf 1 reaches the contact point.

Operation WITH Encoder

Leaf 1 will stop as soon as it reaches the contact point. If there is no mechanical stop, stop the leaf movement at the desired point by sending an OPEN A pulse.

5. On the display **52** will flash (only if 2 motors have been selected): leaf 2 begins opening.

Operation WITHOUT Encoder

Stop movement by sending an OPEN A pulse as soon as leaf 2 reaches the contact point.

Operation WITH Encoder

Leaf 2 will stop as soon as it reaches the contact point. If there is no mechanical stop, stop the leaf movement at the desired point by sending an OPEN A pulse.

6. On the display **53** will flash (only if 2 motors have been selected): leaf 2 begins closing.

Operation WITHOUT Encoder

Stop movement by sending an OPEN A pulse as soon as leaf 2 reaches the contact point.

Operation WITH Encoder

Leaf 2 will stop as soon as it reaches the contact point. If there is no mechanical stop, stop the leaf movement at the desired point by sending an OPEN A pulse.

7. On the display **54** flashes: leaf 1 begins closing.

Operation WITHOUT Encoder

Stop movement by sending an OPEN A pulse as soon as leaf 1 reaches the contact point.

Operation WITH Encoder

Leaf 1 will stop as soon as it reaches the contact point. If there is no mechanical stop, stop the leaf movement at the desired point by sending an OPEN A pulse.

8. The board will automatically exit the programming menu and will display the automated system status (**00**) to confirm that the SETUP procedure has been completed correctly. If the procedure is not completed correctly, on the display **50** will start flashing, indicating that a new SETUP procedure must be performed.

 *The deceleration spaces can be configured and modified from the display using the parameters **r1** and **r2** (see Advanced Programming) without repeating the SETUP.*

5.5 TESTING THE AUTOMATED SYSTEM

Once installation and programming is completed, ensure that the system is operating correctly. Be especially careful that the safety devices operate correctly and ensure that the system complies with all current safety regulations. Close the cover in the provided seat with gasket.

6. MEMORISING THE RADIO CODE

The control board features an integrated 2-channel decoding system (DS, SLH/SLH LR, RC) called OMNIDEC. This system lets you memorise, using an additional receiver module (on J5 connector) and more radio controls having different technology but the same frequency. You can thus control both total opening (OPEN A) and partial opening (OPEN B).

 The different types of radio code (DS, SLH/SLH LR, LC/RC) can coexist simultaneously on the two channels. You can enter up to 255 radio codes divided between OPEN A and OPEN B/CLOSE.

To use different encoding systems on the same channel, you must complete the learning of each encoding system and then repeat the procedure for the other one.

 **Keep the remote control at least 30 cm from the receiver.**

6.1 MEMORISING THE SLH/SLH LR RADIO CONTROLS

1. Press and hold +/R1 - SW1 (OPEN A programming) or -/R2 - SW2 (OPEN B/CLOSE programming).
 - After keeping the button pressed for about 5 sec, the corresponding radio LED (DL11 or DL12) will begin to flash slowly for about 20 sec.
2. Release the button.
3. Simultaneously press and hold P1 and P2 on the SLH/SLH LR radio control (only MASTER radio control).
 - The radio control LED will begin to flash.
4. Release both buttons.
 - Ensure that LED DL11 or DL12 on the board is still flashing (see point 2) and, while the radio control LED is still flashing, press and hold the desired button on the radio control (the radio control LED will go on steady).
 - The corresponding LED on the board (DL11 or DL12) will go on steady for 1 sec and then go off, indicating that memorisation has been completed.
5. Release the radio control button.
6. To complete memorisation, press the button of the memorised radio control twice in succession.
 - The automated system will perform an opening cycle.

 **Ensure that there are no obstacles (by people or things) during the automated system movement.**

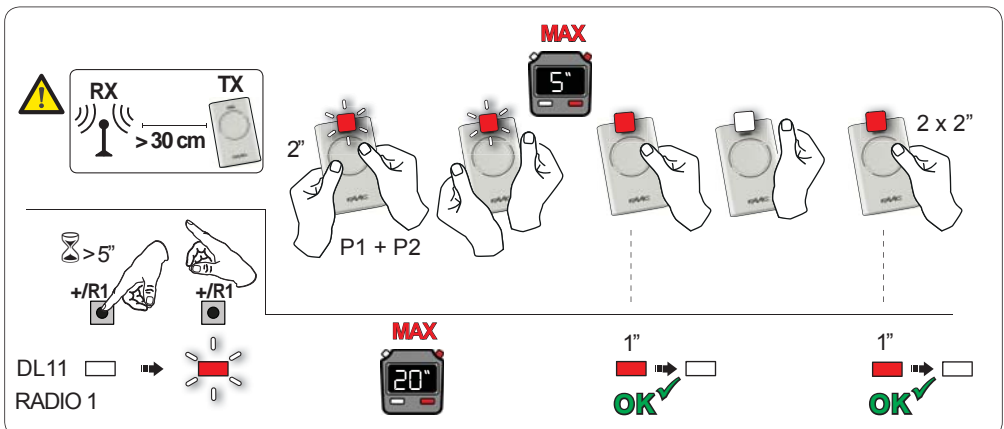

To enable other radio controls with the same system code, you must transfer the system code of the memorised radio control button to the button corresponding to the radio control you wish to add:

1. Simultaneously press and hold P1 and P2 on the memorised radio control.
 - The radio control LED will begin to flash.
2. Release both buttons.
3. Press and hold, while the radio control LED is still flashing, the memorised button (the radio control LED will go on steady).
4. Bring the radio controls close together, press and hold the corresponding button of the radio control you wish to add, and release only after the radio control LED flashes twice, indicating that memorisation has been completed.
5. Press the button of the memorised radio control twice in succession.
 - The automated system will perform an opening cycle.

⚠ Ensure that there are no obstacles (by people or things) during the automated system movement.

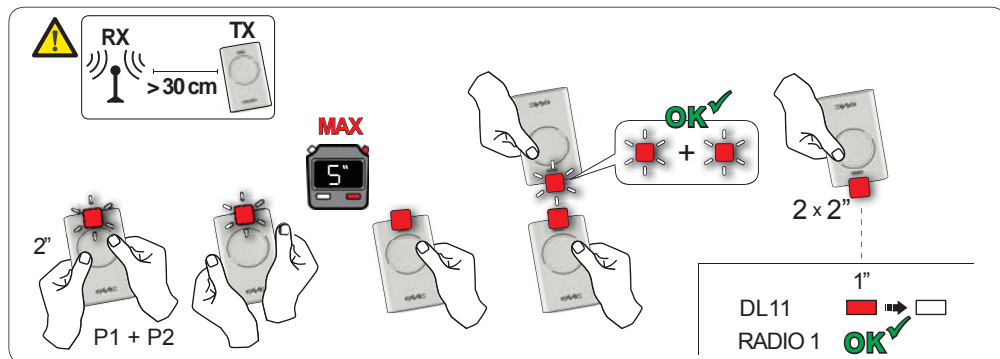

6.2 MEMORISING LC/RC RADIO CONTROLS (ONLY 433 MHZ)

1. Press and hold +/R1 - SW1 (OPEN A programming) or -/R2 - SW2 (OPEN B/CLOSE programming).
- After keeping the button pressed for about 5 sec, the corresponding radio LED (DL11 or DL12) will begin to flash slowly for about 20 sec.
2. Release the button.
3. During radio LED flashing, press the desired button of the LC/RC radio control.
 - The corresponding LED on the board (DL11 or DL12) will go on steady for 1 second, indicating that memorisation has been completed, and will begin flashing again for another 20 sec during which you can memorise another radio control.
 - When the 20 sec have elapsed, the LED will turn off, indicating that the procedure has been completed.
4. To add other radio controls, repeat the procedure from point 1.

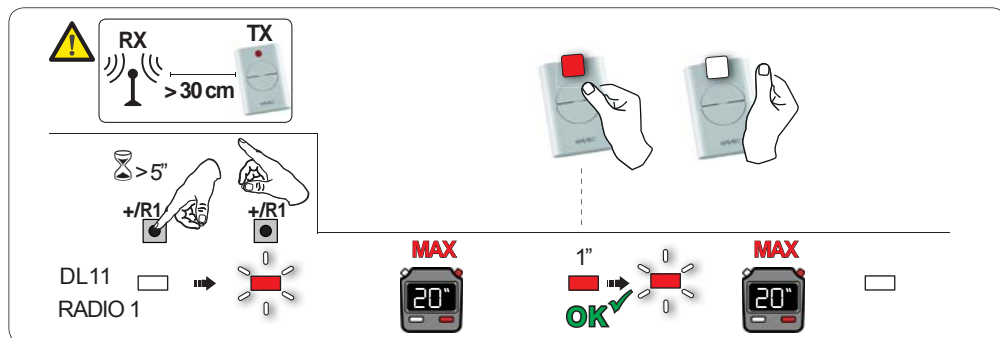

6.2.1 REMOTE MEMORISATION OF LC/RC RADIO CONTROLS

With LC/RC radio controls you can remotely memorise other radio controls, i.e. without working directly on the board, using a previously memorised radio control.

1. Take a radio control that has already been memorised on one of the 2 channels (OPEN A or OPEN B/CLOSE) and move to the vicinity of the board.
2. Simultaneously press and hold P1 and P2 until both LEDs flash slowly for 5 sec.
3. Within 5 seconds, press the previously memorised radio control button to activate the learning phase for the selected channel.
4. The LED on the board corresponding to the channel in learning mode will flash for 20 sec within which another radio control code is transmitted by pressing the button.
 - The corresponding LED on the board will go on steady for 2 sec (indicating that memorisation has been completed) and will begin flashing again for another 20 sec, during which you can memorise other radio controls, and will finally go off.

6.3 MEMORISING DS RADIO CONTROLS

1. On the DS radio control, choose the desired ON - OFF combination of the 12 dip-switches.
2. Press and hold +/R1 - SW1 (OPEN A programming) or -/R2 - SW2 (OPEN B/CLOSE programming).
 - After keeping the button pressed for about 5 sec, the corresponding radio LED (DL11 or DL12) will begin to flash slowly for about 20 sec.
3. Release the button.
4. During radio LED flashing, press the button of the radio control you wish to program.
 - The corresponding LED on the board (DL11 or DL12) will go on steady for 1 second and then go off, indicating that memorisation has been completed.
5. To add other different codes, repeat the procedure starting from point 1.
6. To add other radio controls with the same code, set the 12 dip-switches according to the same combination as the already memorised radio control.

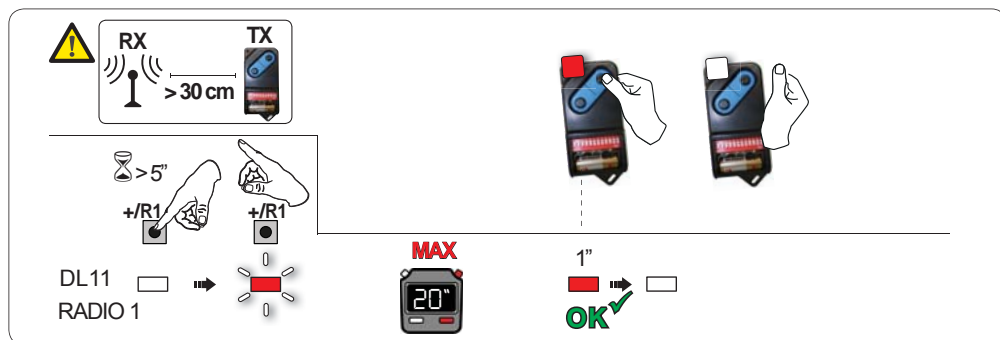

6.4 DELETING THE RADIO CONTROLS

 **This operation CANNOT be reversed. This will delete ALL the radio control codes memorised as both OPEN A and OPEN B/CLOSE. The cancellation procedure is active only in gate status visualisation mode.**



1. Press and hold -/R2 .
 - After pressing for about 5 sec, the DL12 LED begins to flash slowly; after another 5 sec of slow flashing and holding, the LEDs DL11 and DL12 begin flashing more rapidly (cancellation has started).
 - Once rapid flashing has stopped, LEDs DL11 and DL12 will go on steady, confirming the cancellation of all the radio codes (OPEN A and OPEN B/CLOSE) from the board memory.

2. Release -/R2 . The LEDs will go off, indicating correct cancellation.



7. START-UP

7.1 CHECKING THE LEDs

After having made all the connections and powered the board, check the status of the LEDs in relation to the status of the inputs (the Figure shows the condition of closed automated system).

ENGLISH

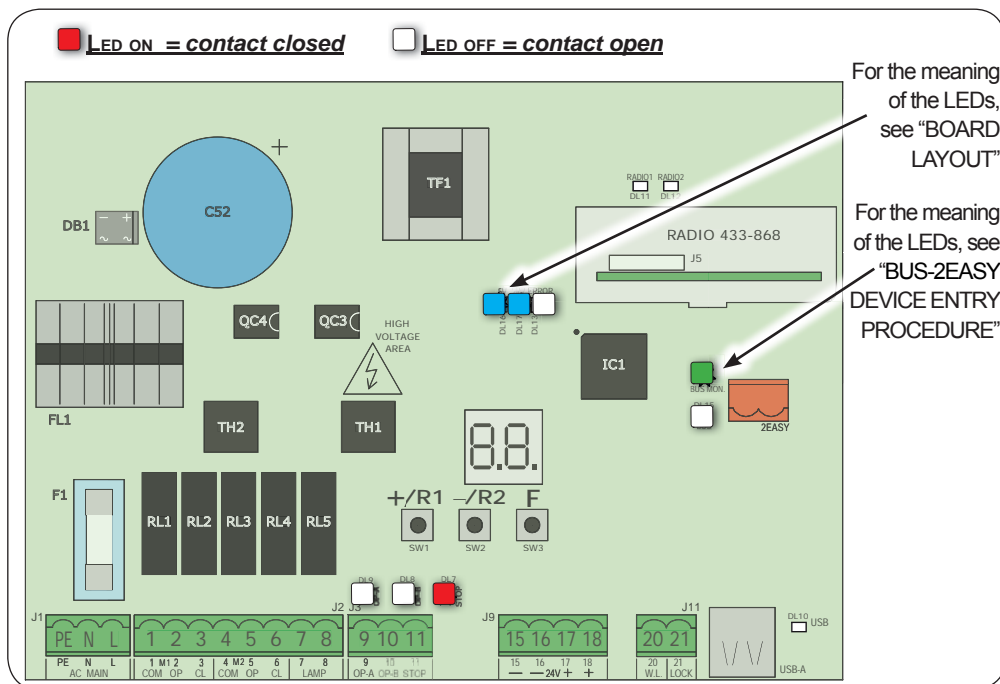

STOP - In default configuration, the STOP input is a safety input with contact N.C. (Normally Closed). The corresponding LED must be ON with the automated system at rest and go off when the connected device is activated.

OPEN A, OPEN B - In default configuration, the OPEN A, OPEN B inputs are inputs with contact N.O. (Normally Open). The corresponding LEDs must be OFF when the automated system is at rest, and go ON when the connected device is in use.

Led ERROR - FLASHING = there is an alarm in progress (situation that does not compromise gate operation) - see "ALARMS". **ON STEADY** = there is an error in progress (situation that blocks operation until the cause of the fault has been eliminated). See "ERRORS".

8. SIGNALLING ERRORS AND ALARMS

In case of **ERRORS** (conditions that stop gate operation) or **ALARMS** (conditions that do not compromise gate operation) the display will show the number corresponding to the warning in progress by simultaneously pressing **+** and **-**.

 *These warnings will disappear in the following cycle only if the situation causing them is removed.*

8.1 ERRORS

 *When there is an ERROR the **ERROR LED** will go on steady. By simultaneously pressing **+** and **-** the display will show the corresponding error number.*

The following table contains all the errors that can be viewed on the display.

N°	ERROR	SOLUTION
01	Board broken	Replace the board
05	Invalid SETUP	Repeat board SETUP
08	BUS-2EASY device error	Ensure that no two pairs of devices have the same address.
09	BUS-2EASY output short-circuit	Check the connections of the connected and entered BUS-2EASY devices
12	BUS-2EASY call	Ensure that the BUS devices are operating correctly and, if necessary, repeat BUS device acquisition
13	FAIL SAFE	Check that the safety devices (photocells) are operating correctly
14	Configuration error	Check that the board is configured correctly (basic and advanced programming) and, if necessary, repeat SETUP
17	Motor 1 encoder fault	Check the connections or replace motor 1 encoder
18	Motor 2 encoder fault	Check the connections or replace motor 2 encoder
19	Incorrect memory data	Repeat BUS-2EASY device entry and/or re-program the board

8.2 ALARMS

 When there is an ALARM the **ERROR LED** will begin to flash. By simultaneously pressing + and - the display will show the corresponding alarm number.

The following table contains all the alarms that can be viewed on the display.

N°	ALARM	Solution/Description
20	Obstacle on MOTOR 1 (only with encoder)	Remove any possible obstacle on leaf 1
21	Obstacle on MOTOR 2 (only with encoder)	Remove any possible obstacle on leaf 2
25	LOCK 1 output short-circuit	Remove the cause of the short-circuit
28	Nr. of consecutive obstacles exceeded during closing	Remove any possible obstacle. Should the problem persist, repeat SETUP
30	XF radio code memory full	Cancel the radio codes.
31	Breach alarm	A movement was made with the automated system in status SE = 00 or 01 . Perform an operation cycle.

9. TROUBLESHOOTING

	Description	Solution
A	The board does not turn on	<ul style="list-style-type: none"> Ensure that the board is receiving the 230V~ Ensure that fuse F1 is intact
B	The gate will not open after an OPEN pulse	<ul style="list-style-type: none"> Check that the safety devices and STOP are connected to the negative and ensure that the corresponding LEDs are ON Check the photocells (alignment, engagement) Check that the SETUP has been completed correctly. Repeat if necessary
C	The gate does not reverse when the photocells are engaged	<ul style="list-style-type: none"> Check that the traditional photocells are correctly wired and that the BUS photocell configuration is correct (if present). If necessary, repeat the acquisition of the BUS-2EASY devices
D	The gate does not reverse when encountering an obstacle	<ul style="list-style-type: none"> Ensure that the encoders on motors are enabled Check the obstacle detection sensitivity
E	The gate will not close	<ul style="list-style-type: none"> Check that the photocell wiring and alignment is correct Check that there is no OPEN signal active Check which function logic has been chosen (automatic or semi-automatic)

10. MANAGING THE CONFIGURATION FILE – J8 USB

Using the J8 USB connector you can both transfer to the board the configuration and management files from a USB drive and copy the same files stored on the board to the USB memory. When transferring from the USB memory to the board, the files must be located in the memory root, as shown in the screenshot below:

In addition, the names and extensions of the various files must be as follows:

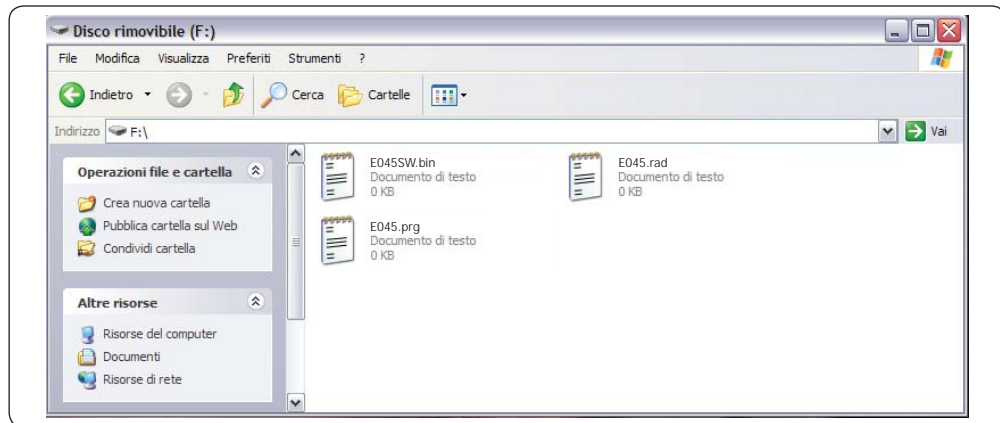











ENGLISH



- **E045SW.bin** - The board SOFTWARE update file
- **E045.prg** - The board PROGRAMMING update file
- **E045.rad** - The board RADIO update file

These files will be generated, named and placed as shown in fig. in case of transfer from the board to the USB memory.

If at board power up a USB memory is detected inserted in the board J8 connector, after displaying the writing **U**, it will be possible to access the update file management menu (see the following table) (press **F** for scrolling through the functions) :

Display	Function	Default
<p>US</p>	<p>BOARD SOFTWARE UPGRADE:</p> <p>This function lets you update the board application (file E045SW.bin).</p> <p>If + and - are pressed simultaneously for at least 5 seconds, you will access the board update. The writing U will disappear and, in its place, the writing -- and the USB DL10 LED will begin flashing.</p> <p>Once updating is completed, U will be displayed if it has been done correctly, otherwise the writing U will appear again.</p> <p> The upgrade is carried out correctly only if the USB memory contains a valid file named exactly E045SW.bin</p>	<p>--</p>

Display	Function	Default
	<p>BOARD CONFIGURATION UPGRADE:</p> <p>This function lets you transfer the configuration to the board (file E045.prg). If + and - are pressed simultaneously for at least 5 seconds, you will access the board configuration update. The writing  will disappear and, in its place, the writing -- and the USB DL10 LED will begin flashing. Once updating is completed,  will be displayed if it has been done correctly, otherwise the writing  will appear again.</p> <p> <i>The upgrade is carried out correctly only if the USB memory contains a valid file named exactly E045.prg</i></p>	<p>--</p>
	<p>RADIO CODE LIST UPGRADE:</p> <p>This function lets you update the radio code list on the board (file E045.rad). If + and - are pressed simultaneously for at least 5 seconds, you will access the board update. The writing  will disappear and, in its place, the writing -- and the USB DL10 LED will begin flashing. Once updating is completed  will be displayed if it has been done correctly, otherwise the writing  will appear again.</p> <p> <i>The upgrade is carried out correctly only if the USB memory contains a valid file named exactly E045.rad</i></p>	<p>--</p>

Display	Function	Default
	<p>BOARD CONFIGURATION DOWNLOAD:</p> <p>This function lets you save the board configuration in the USB memory in order to store (parameter 01) or copy the configuration to other systems (parameter 00).</p> <p>If + and - are pressed simultaneously for at least 5 seconds, the following selection values will appear:</p> <p>01 = Storage: the configuration file will be saved in the format E045_xxx.prg where xxx=000/001/002 etc. depending on how many configuration files there are in the USB memory.</p> <p>00 = Copy: the configuration file will be saved in the format E045.prg by overwriting any other configuration file present with the same name, so it can be used to upgrade another system.</p> <p>Press + and - to select the desired parameter and, by pressing F, the board will proceed to save the file and display Y when done correctly, or n0 in case of errors during saving.</p>	<p>--</p>
	<p>BOARD RADIO CODE DOWNLOAD:</p> <p>This function lets you save in the USB memory the board radio codes in order to store (parameter 01) or copy the radio codes to other systems (parameter 00).</p> <p>If + and - are pressed simultaneously for at least 5 seconds, the following selection values will appear:</p> <p>01 = Storage: the radio codes file will be saved in the format E045_xxx.rad where xxx=000/001/002 etc. depending on how many radio codes files there are in the USB memory.</p> <p>00 = Copy: the radio codes file will be saved in the format E045.rad by overwriting any other radio codes file present with the same name, so it can be used to upgrade another system.</p> <p>Press + and - to select the desired parameter and, by pressing F, the board will proceed to save the file and display Y when done correctly, or n0 in case of errors during saving.</p>	<p>--</p>

11. FUNCTION LOGICS



This table summarizes the function logics.

For a detailed description of each one, see the queued Tables.

LOGIC		Automated system status: stopped	Automated system status: in motion	Status: photocell involvement
E	Semiautomatic	An OPEN pulse opens the gate and the following one will close it	An OPEN pulse while opening stops and reopens during closing	During motion, the photocells reverse
EP	Semiautomatic, Step-by-Step	An OPEN pulse opens the gate and the following one will close it	An OPEN pulse during motion blocks	During motion, the photocells reverse
SP	Automatic Safety Step-by-Step	An OPEN pulse opens the gate and closes automatically after the pause time	An OPEN pulse during pause closes and during motion blocks the operation	The closing photocells reclose the gate during pause; they memorise closing during opening and immediately reverse during closing
A	Automatic	An OPEN pulse opens the gate and closes automatically after the pause time	An OPEN pulse during opening is ignored, during pause it recharges the pause time and during closing it reopens the leaves	The closing photocells recharge the pause time
AP	Automatic Step-by-Step	An OPEN pulse opens the gate and closes automatically after the pause time	An OPEN pulse during opening and during pause blocks the operation; it reverses during closing	The closing photocells recharge the pause time
b	Semiautomatic "b" (OPEN-B inputs become CLOSE)	Logic with two separate commands: OPEN-A pulse opens; CLOSE pulse closes	An OPEN-A pulse during closing opens, a CLOSE pulse during opening closes	During motion, the photocells reverse
C	Dead-man (OPEN-B inputs become CLOSE)	Logic with two separate commands: a held OPEN-A pulse opens; a held CLOSE pulse closes	An OPEN-A pulse during closing opens, a CLOSE pulse during opening closes	During motion, the photocells reverse



ENGLISH



E SEMI-AUTOMATIC LOGIC

AUTOMATED SYSTEM STATUS	PULSES						
	OPEN A	OPEN B	CLOSE	STOP	FSW OP	FSW CL	FSW CL/OP
CLOSED	OPENS	OPENS PARTIALLY	NO EFFECT	NO EFFECT (OPEN DISABLED)		NO EFFECT	NO EFFECT (OPEN DISABLED)
OPENING	STOPS*  ¹	STOPS*	CLOSES	STOPS*	REVERSES	NO EFFECT	STOPS; OPENS AT RELEASE (OPEN STOPS* - SAVES CLOSE)
OPEN	CLOSES  ¹	CLOSES		NO EFFECT (OPEN/CLOSE DISABLED)	NO EFFECT	NO EFFECT (CLOSE DISABLED)	NO EFFECT (OPEN/CLOSE DISABLED)
CLOSING	OPENS		NO EFFECT	STOPS*	NO EFFECT	REVERSES  ²	STOPS; OPENS AT RELEASE (OPEN STOPS* - SAVES CLOSE)
STOPPED	CLOSES			NO EFFECT (OPEN/CLOSE DISABLED)	NO EFFECT (OPEN DISABLED)	NO EFFECT (CLOSE DISABLED)	NO EFFECT (OPEN STOPS - SAVES CLOSE)

ENGLISH



EP SEMI-AUTOMATIC “STEP-BY-STEP” LOGIC

AUTOMATED SYSTEM STATUS	PULSES						
	OPEN A	OPEN B	CLOSE	STOP	FSW OP	FSW CL	FSW CL/OP
CLOSED	OPENS	OPENS PARTIALLY	NO EFFECT	NO EFFECT (OPEN DISABLED)		NO EFFECT	NO EFFECT (OPEN DISABLED)
OPENING	STOPS*  ¹	STOPS*	CLOSES	STOPS*	REVERSES	NO EFFECT	STOPS; OPENS AT RELEASE (OPEN STOPS* - SAVES CLOSE)
OPEN	CLOSES  ¹	CLOSES		NO EFFECT (OPEN/CLOSE DISABLED)	NO EFFECT	NO EFFECT (CLOSE DISABLED)	NO EFFECT (OPEN/CLOSE DISABLED)
CLOSING	STOPS*		NO EFFECT	STOPS*	NO EFFECT	REVERSES  ²	STOPS; OPENS AT RELEASE (OPEN STOPS* - SAVES CLOSE)
STOPPED	RESTARTS MOVING IN THE OPPOSITE DIRECTION. ALWAYS CLOSES AFTER STOP		CLOSES	NO EFFECT (OPEN/CLOSE DISABLED)	NO EFFECT (OPEN DISABLED)	NO EFFECT (CLOSE DISABLED)	NO EFFECT (OPEN STOPS - SAVES CLOSE)

¹ if the cycle began with OPEN-B, opens totally
² operation can be modified by programming

SP AUTOMATIC “SAFETY” “STEP-BY-STEP” LOGIC



PULSES



AUTOMATED SYSTEM STATUS	OPEN A	OPEN B	CLOSE	STOP	FSW OP	FSW CL	FSW CL/OP
CLOSED	OPENS; CLOSES AFTER PAUSE TIME	OPENS PARTIALLY; CLOSES AFTER PAUSE TIME	NO EFFECT	NO EFFECT (OPEN DISABLED)		NO EFFECT	NO EFFECT (OPEN DISABLED)
OPENING	STOPS*  ¹	STOPS*	CLOSES	STOPS*	REVERSES	COMPLETES THE OPENING, THEN CLOSES WITHOUT PAUSE TIME	STOPS; OPENS AT RELEASE, THEN CLOSES WITHOUT PAUSE TIME (OPEN STOPS* - SAVES CLOSE)
OPEN IN PAUSE	CLOSES  ¹	CLOSES		STOPS*	NO EFFECT	STOPS; CLOSES AT RELEASE	
CLOSING	STOPS*		NO EFFECT	STOPS*	NO EFFECT	REVERSES  ²	STOPS; OPENS AT RELEASE (SAVES CLOSE)
*STOPPED	RESTARTS MOVING IN THE OPPOSITE DIRECTION. ALWAYS CLOSES AFTER STOP		CLOSES	NO EFFECT (OPEN/CLOSE DISABLED)	NO EFFECT (OPEN DISABLED)	NO EFFECT (CLOSE DISABLED)	NO EFFECT (OPEN/CLOSE DISABLED)

ENGLISH



A AUTOMATIC LOGIC

PULSES

AUTOMATED SYSTEM STATUS	OPEN A	OPEN B	CLOSE	STOP	FSW OP	FSW CL	FSW CL/OP
CLOSED	OPENS; CLOSES AFTER PAUSE TIME	OPENS PARTIALLY; CLOSES AFTER PAUSE TIME	NO EFFECT	NO EFFECT (OPEN DISABLED)		NO EFFECT	NO EFFECT (OPEN DISABLED)
OPENING	NO EFFECT  ¹	NO EFFECT	CLOSES	STOPS*	REVERSES	NO EFFECT	STOPS; OPENS AT RELEASE (SAVES CLOSE)
OPEN IN PAUSE	RECHARGES PAUSE TIME  ¹	RECHARGES PAUSE TIME	CLOSES	STOPS*	NO EFFECT	RECHARGES PAUSE TIME (CLOSE DISABLED)	
CLOSING	OPENS		NO EFFECT	STOPS*	NO EFFECT	REVERSES  ²	STOPS; OPENS AT RELEASE (SAVES CLOSE)
*STOPPED	CLOSES			NO EFFECT (OPEN/CLOSE DISABLED)	NO EFFECT (OPEN DISABLED)	NO EFFECT (CLOSE DISABLED)	NO EFFECT (OPEN/CLOSE DISABLED)

¹ if the cycle began with OPEN-B, opens totally
² operation can be modified by programming



AP AUTOMATIC “STEP-BY-STEP” LOGIC

AUTOMATED SYSTEM STATUS	PULSES						
	OPEN A	OPEN B	CLOSE	STOP	FSW OP	FSW CL	FSW CL/OP
CLOSED	OPENS; CLOSES AFTER PAUSE TIME	OPENS PARTIALLY; CLOSES AFTER PAUSE TIME	NO EFFECT	NO EFFECT (OPEN DISABLED)		NO EFFECT	NO EFFECT (OPEN DISABLED)
OPENING	STOPS*  ¹	STOPS*	CLOSES	STOPS*	REVERSES (SAVES OPEN)	NO EFFECT	STOPS; OPENS AT RELEASE (OPEN STOPS* - SAVES CLOSE)
OPEN IN PAUSE	STOPS* ¹	STOPS*	CLOSES	STOPS*	NO EFFECT	RECHARGES PAUSE TIME (CLOSE DISABLED)	
CLOSING	OPENS		NO EFFECT	STOPS*	NO EFFECT	REVERSES  ²	STOPS; OPENS AT RELEASE (OPEN STOPS* - SAVES CLOSE)
*STOPPED	CLOSES			NO EFFECT (OPEN/CLOSE DISABLED)	NO EFFECT (OPEN DISABLED)	NO EFFECT (CLOSE DISABLED)	NO EFFECT (OPEN/ CLOSE DISABLED)

ENGLISH

b SEMI-AUTOMATIC “B” LOGIC (OPEN-B INPUTS BECOME CLOSE)

AUTOMATED SYSTEM STATUS	PULSES						
	OPEN A	OPEN B	CLOSE	STOP	FSW OP	FSW CL	FSW CL/OP
CLOSED	OPENS	NO EFFECT		NO EFFECT (OPEN DISABLED)		NO EFFECT	NO EFFECT (OPEN DISABLED)
OPENING	NO EFFECT	CLOSES		STOPS*	REVERSES	NO EFFECT	STOPS; CLOSES AT RELEASE (SAVES OPEN/CLOSE)
OPEN	NO EFFECT	CLOSES		NO EFFECT (OPEN/CLOSE DISABLED)	NO EFFECT	NO EFFECT (CLOSE DISABLED)	NO EFFECT (OPEN/ CLOSE DISABLED)
CLOSING	OPENS	NO EFFECT		STOPS*	NO EFFECT	REVERSES  ²	STOPS; OPENS AT RELEASE (SAVES OPEN/CLOSE)
*STOPPED	OPENS	CLOSES		NO EFFECT (OPEN/CLOSE DISABLED)	NO EFFECT (OPEN DISABLED)	NO EFFECT (CLOSE DISABLED)	NO EFFECT (OPEN/ CLOSE DISABLED)

 ¹ if the cycle began with OPEN-B, opens totally
 ² operation can be modified by programming

DEAD-MAN LOGIC (OPEN-B INPUTS BECOME CLOSE)

AUTOMATED SYSTEM STATUS	DEAD-MAN COMMANDS			PULSES			
	OPEN A	OPEN B	CLOSE	STOP	FSW OP	FSW CL	FSW CL/OP
CLOSED	OPENS	NO EFFECT		NO EFFECT (OPEN DISABLED)		NO EFFECT	NO EFFECT (OPEN DISABLED)
OPENING	NO EFFECT	CLOSES		STOPS*	REVERSES	NO EFFECT	STOPS; CLOSES AT RELEASE (SAVES OPEN/CLOSE)
OPEN	NO EFFECT	CLOSES		NO EFFECT (OPEN/CLOSE DISABLED)	NO EFFECT	NO EFFECT (CLOSE DISABLED)	NO EFFECT (OPEN/CLOSE DISABLED)
CLOSING	OPENS	NO EFFECT		STOPS*	NO EFFECT	REVERSES ^{1,2}	STOPS; OPENS AT RELEASE (SAVES OPEN/CLOSE)
*STOPPED	OPENS	CLOSES		NO EFFECT (OPEN/CLOSE DISABLED)	NO EFFECT (OPEN DISABLED)	NO EFFECT (CLOSE DISABLED)	NO EFFECT (OPEN/CLOSE DISABLED)

ENGLISH

¹ if the cycle began with OPEN-B, opens totally
² operation can be modified by programming

SEDE - HEADQUARTERS

FAAC S.p.A.

Via Calari, 10
40069 Zola Predosa (BO) - ITALY
Tel. +39 051 61724 - Fax +39 051 758518
www.faac.it - www.faacgroup.com

ASSISTENZA IN ITALIA

SEDE

tel. +39 051 6172501
www.faac.it/ita/assistenza

FIRENZE

tel. +39 055 301194
filiale.firenze@faacgroup.com

MILANO

tel +39 02 66011163
filiale.milano@faacgroup.com

PADOVA

tel +39 049 8700541
filiale.padova@faacgroup.com

ROMA

tel +39 06 41206137
filiale.roma@faacgroup.com

TORINO

tel +39 011 6813997
filiale.torino@faacgroup.com

SUBSIDIARIES

AUSTRIA

FAAC GMBH
Salzburg - Austria
tel. +43 662 8533950
www.faac.at

FAAC TUBULAR MOTORS

tel. +49 30 56796645
faactm.info@faacgroup.com
www.faac.at

AUSTRALIA

FAAC AUSTRALIA PTY LTD
Homebush, Sydney - Australia
tel. +61 2 87565644
www.faac.com.au

BENELUX

FAAC BENELUX NV/SA
Brugge - Belgium
tel. +32 50 320202
www.faacbenelux.com

FAAC TUBULAR MOTORS

tel. +31 475 406014
faactm.info@faacgroup.com
www.faacbenelux.com

CHINA

FAAC SHANGHAI
Shanghai - China
tel. +86 21 68182970
www.faacgroup.cn

FRANCE

FAAC FRANCE
Saint Priest, Lyon - France
tel. +33 4 72218700
www.faac.fr

FAAC FRANCE - AGENCE PARIS

Massy, Paris - France
tel. +33 1 69191620
www.faac.fr

FAAC FRANCE - DEPARTEMENT VOLETS

Saint Denis de Pile - Bordeaux - France
tel. +33 5 57551890
www.faac.fr

GERMANY

FAAC GMBH
Freilassing - Germany
tel. +49 8654 49810
www.faac.de

FAAC TUBULAR MOTORS

tel. +49 30 5679 6645
faactm.info@faacgroup.com
www.faac.de

INDIA

FAAC INDIA PVT. LTD
Noida, Delhi - India
tel. +91 120 3934100/4199
www.faacindia.com

IRELAND

NATIONAL AUTOMATION LIMITED
Boyle, Co. Roscommon - Ireland
tel. +353 071 9663893
www.faac.ie

MIDDLE EAST

FAAC MIDDLE EAST FZE
Dubai Silicon Oasis free zone
tel. +971 4 372 4187
www.faac.ae

NORDIC REGIONS

FAAC NORDIC AB
Perstorp - Sweden
tel. +46 435 779500
www.faac.se

POLAND

FAAC POLSKA SP.ZO.O
Warszawa - Poland
tel. +48 22 8141422
www.faac.pl

RUSSIA

FAAC RUSSIA LLC
Moscow - Russia
tel. +7 495 646 24 29
www.faac.ru

SPAIN

CLEM, S.A.U.
S. S. de los Reyes, Madrid - Spain
tel. +34 091 358 1110
www.faac.es

SWITZERLAND

FAAC AG
Altdorf - Switzerland
tel. +41 41 8713440
www.faac.ch

TURKEY

FAAC OTOMATİK GEÇİŞ SİSTEMLERİ
SAN. VE TİC. LTD. ŞTİ.
Çağlayan, Kağıthane, İstanbul - Turkey
tel. +90 (0)212 - 3431311
www.faac.com.tr

UNITED KINGDOM

FAAC UK LTD.
Basingstoke, Hampshire - UK
tel. +44 1256 318100
www.faac.co.uk

U.S.A.

FAAC INTERNATIONAL INC
Rockledge, Florida - U.S.A.
tel. +1 904 4488952
www.faacusa.com

FAAC INTERNATIONAL INC
Fullerton, California - U.S.A.
tel. +1 714 446 9800
www.faacusa.com

FAAC